

N° de Ref. : 260

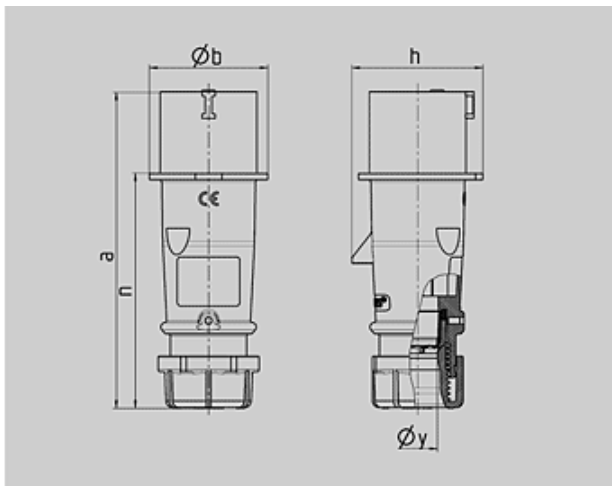





Clavija AM-TOP

carcasa de una pieza, prensaestopas roscado con estanqueidad, antitracción y protección contra deformaciones del cable



| Plano | Amp. | 16 | | | 32 | | |
|--|--------------|-------|-------|-------|-----|-----|------|
| | | 3 | 4 | 5 | 3 | 4 | 5 |
| 2 MB 217 | Polos | | | | | | |
| Dim. en mm | a | 142 | 147 | 147 | 186 | 186 | 180 |
| | b | 53 | 59 | 67 | 70 | 70 | 77 |
| | h | 59 | 69,4 | 76 | 81 | 81 | 89,5 |
| | n | 105,2 | 110,5 | 110,5 | 141 | 141 | 135 |
| | y | 14,5 | 16 | 16 | 22 | 22 | 22 |
| Borna para cond. Sección Transvers. (mm ²) min.-máx. | | 1 | 1 | 1 | 2,5 | 2,5 | 2,5 |
| | | -2,5 | -2,5 | -2,5 | -6 | -6 | -6 |

| | |
|------------------------------|--------|
| Grupo de artículos : | 2141 |
| voltages : | 230V |
| rated current : | 32A |
| pole : | 3 pole |
| IP protection types : | IP44 |
| position of ground contact : | 6h |
| packing unit : | 0010 |
| Peso : | 208 g |

| N° DE REF. | | 110V | 230V | 400V | 500V | >50-500V | |
|--------------|---|---|---|---|---|---|---|
| Hz | | 50,60 | 50,60 | 50,60 | 50,60 | 100-300 | 300-500 |
| Color código | |  |  |  |  |  |  |
| Amperios | | | | | | | |
| 16 A | 3 | 247 | 248 | 249 | | 2168 | 2271 |
| | 4 | 250 | 251 | 252 | 253 | 254 | 255 |
| | 5 | 256 | 257 | 3 | 2014 | 2189 | 2243 |
| 32 A | 3 | 259 | <u>260</u> | 261 | | 2195 | 2341 |
| | 4 | 262 | 263 | 264 | 265 | 266 | 267 |
| | 5 | 268 | 269 | 4 | 2015 | 2244 | 2178 |