

N° de Ref. : 264

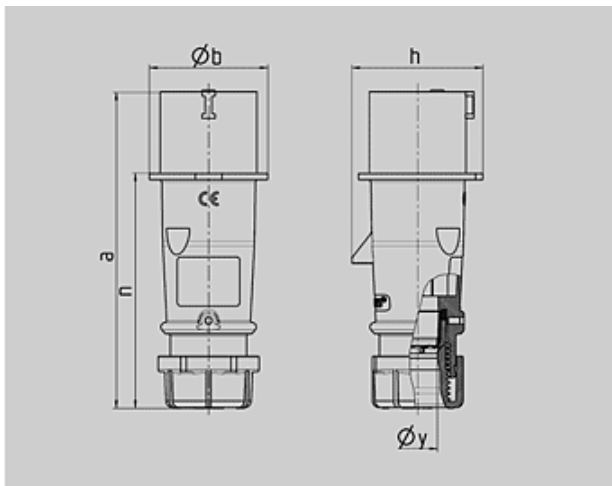





Clavija AM-TOP

carcasa de una pieza, prensaestopas roscado con estanqueidad, antitracción y protección contra deformaciones del cable



Plano	Amp.	16			32		
		2 MB 217 Polos			3	4	5
Dim. en mm	a	142	147	147	186	186	180
	b	53	59	67	70	70	77
	h	59	69,4	76	81	81	89,5
	n	105,2	110,5	110,5	141	141	135
	y	14,5	16	16	22	22	22
Borna para cond. Sección Transvers. (mm ²) min.-máx.		1	1	1	2,5	2,5	2,5
		-2,5	-2,5	-2,5	-6	-6	-6

Grupo de artículos :	2141
voltages :	400V
rated current :	32A
pole :	4 pole
IP protection types :	IP44
position of ground contact :	6h
packing unit :	0010
Peso :	222 g

N° DE REF.	V	110V	230V	400V	500V	>50-500V		
		Hz	50,60	50,60	50,60	50,60	100-300	300-500
Color código	Amperios							
	16 A	3	247	248	249		2168	2271
		4	250	251	252	253	254	255
	5	256	257	3	2014	2189	2243	
32 A	3	259	260	261		2195	2341	
	4	262	263	264	265	266	267	
	5	268	269	4	2015	2244	2178	