

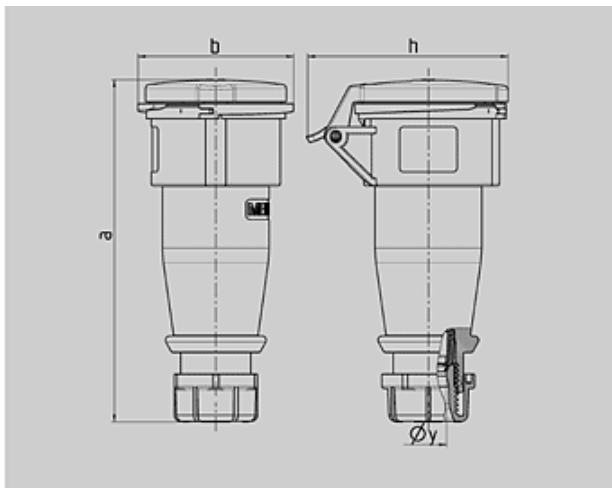

N° de Ref. : 526







Prolongador AM-TOP

carcasa de una pieza, prensaestopas roscado con estanqueidad, antitracción y protección contra deformaciones del cable



| Plano | Amp. 3 MB 63 Polos | 16 | | | 32 | | |
|--|--------------------------|------|------|------|-----|-----|-----|
| | | 3 | 4 | 5 | 3 | 4 | 5 |
| Dim. en mm | a | 162 | 165 | 167 | 209 | 209 | 208 |
| | b | 60 | 68 | 76 | 82 | 82 | 89 |
| | h | 83 | 92 | 98 | 100 | 100 | 108 |
| | y | 14,5 | 16 | 16 | 22 | 22 | 22 |
| Borna para cond. Sección Transvers. (mm²) min.-max. | | 1 | 1 | 1 | 2,5 | 2,5 | 2,5 |
| | | -2,5 | -2,5 | -2,5 | -6 | -6 | -6 |

| | |
|------------------------------|--------|
| Grupo de artículos : | 3141 |
| voltages : | 400V |
| rated current : | 32A |
| pole : | 4 pole |
| IP protection types : | IP44 |
| position of ground contact : | 6h |
| packing unit : | 0010 |
| Peso : | 256 g |

| N° DE REF. | V | 110V | 230V | 400V | 500V | >50-500V | |
|--------------|----------|---|---|---|---|---|---|
| | | Hz | 50,60 | 50,60 | 50,60 | 50,60 | 100-300 |
| Color código | Amperios |  |  |  |  |  |  |
| 16 A | 3 | 509 | 510 | 511 | | 2441 | 2517 |
| | 4 | 512 | 513 | 514 | 515 | 516 | 517 |
| | 5 | 518 | 519 | 5 | 2026 | 2193 | 2495 |
| 32 A | 3 | 521 | 522 | 523 | | 2196 | 2674 |
| | 4 | 524 | 525 | 526 | 527 | 528 | 529 |
| | 5 | 530 | 531 | 6 | 2027 | 2245 | 2493 |