

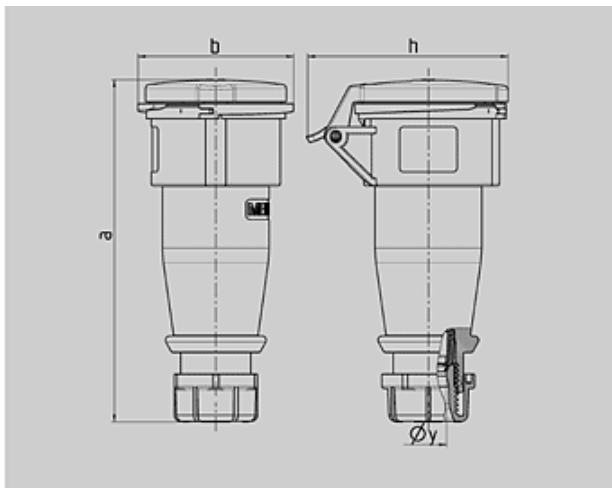

N° de Ref. : 6







Prolongador AM-TOP

carcasa de una pieza, prensaestopas roscado con estanqueidad, antitracción y protección contra deformaciones del cable



Plano	Amp. 3 MB 63 Polos	16			32		
		3	4	5	3	4	5
Dim. en mm	a	162	165	167	209	209	208
	b	60	68	76	82	82	89
	h	83	92	98	100	100	108
	y	14,5	16	16	22	22	22
Borna para cond. Sección Transvers. (mm²) min.-max.		1	1	1	2,5	2,5	2,5
		—2,5	—2,5	—2,5	—6	—6	—6

Grupo de artículos : 3141
voltages : 400V
rated current : 32A
pole : 5 pole
IP protection types : IP44
position of ground contact : 6h
packing unit : 0010
Peso : 300 g

N° DE REF.		110V	230V	400V	500V	>50-500V	
Hz		50,60	50,60	50,60	50,60	100-300	300-500
Color código							
Amperios							
16 A	3	509	510	511		2441	2517
	4	512	513	514	515	516	517
	5	518	519	5	2026	2193	2495
32 A	3	521	522	523		2196	2674
	4	524	525	526	527	528	529
	5	530	531	6	2027	2245	2493