

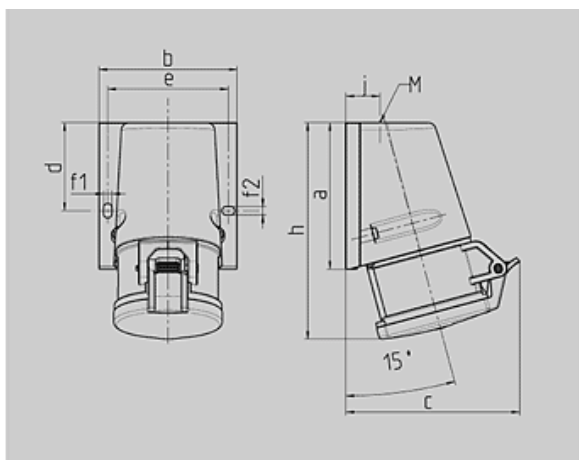

N° de Ref. : 31







**Base con bornes  
de resorte  
TwinCONTACT**

fijación exterior, entrada de cable superior



Plano	Amp. Polos	16		
		3	4	5
1 MB 463				
Dim. en mm	a	95	93	92,5
	b	73,5	87,5	87
	c	93	107,5	110
	d	55,5	55,5	55,5
	e	61	76	76
	f1	5,3	5,3	5,3
	f2	5,3	5,3	5,3
	h	139	139	136,5
	i	19,8	21,5	21,5
	M		M 25 x 1,5	

Grupo de artículos :	<b>1038</b>
voltages :	400V
rated current :	16A
pole :	5 pole
IP protection types :	IP44
position of ground contact :	6h
packing unit :	0010
Peso :	239 g

N° DE REF.	V	110V	230V	400V	500V	>50-500V	
	Hz	50,60	50,60	50,60	50,60	100-300	300-500
	Color código						
	Amperios						
<b>16 A</b>	3	1340	1341				
	4		1342	1343	1344		
	5			<u>31</u>			
<b>32 A</b>	3	1345	1346				
	4		1347	1348	1349		
	5			32			