

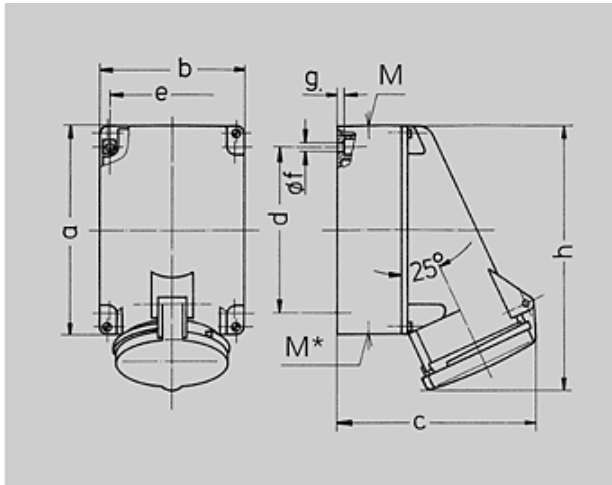

N° de Ref. : 1145A







Base

Fijación interior, una entrada de cable superior y dos ciegas (para cortar) inferiores, parte inferior de la carcasa giratoria 180°, preparada para 6 bornes de conexión AM



Plano	Amp.	63			
		1 MB 213 Polos			
		3	4	5	
Dim. en mm	a	170	170	170	
	b	118	118	118	
	c	164	164	164	
	d	134,5	134,5	134,5	
	e	103	103	103	
	f	6,1	6,1	6,1	
	g	6	6	6	
	h	216	216	216	
	M	40	40	40	
	M*		2x M 40		
	Diám. máx. de cable (mm)		32	32	32
	Borna para cond. Sección Transvers. (mm ²) min.-máx.		6 -25	6 -25	6 -25

Grupo de artículos :	1041
voltages :	400V
rated current :	63A
pole :	5 pole
IP protection types :	IP44
position of ground contact :	6h
packing unit :	0010
Peso :	925 g

N° DE REF.						
V	110V	230V	400V	500V	>50-500V	
Hz	50,60	50,60	50,60	50,60	100-300	300-500
Color código						
Amperios						
63 A	3	1136A	1137A			
	4		1140A	1141A	1142A	
	5			1145A		