

N° de Ref. : 1463

**Base semiempotrable**

inclinación 20°

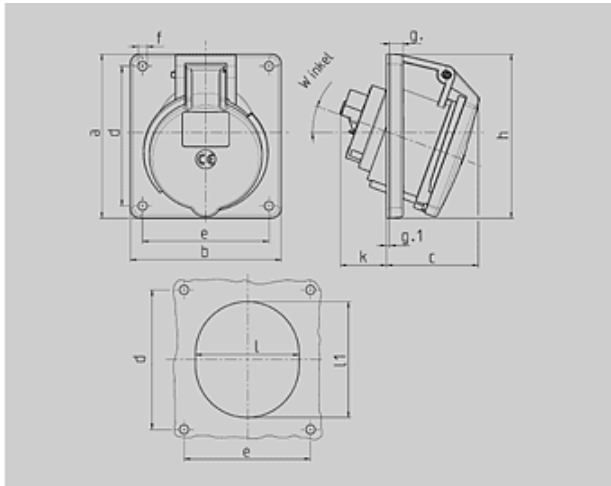

Plano	Amp.	16			32		
		Polos			3	4	5
1 MB 260							
Dim. en mm	a	73,5	100	100	100	100	100
	b	64	92	92	92	92	92
	c	52	58	58	62	62	62
	d	60	85	85	85	85	85
	e	52	77	77	77	77	77
	f	5,5	5,5	5,5	5,5	5,5	5,5
	g	7	8	8	8	8	8
	g.1	2	2	2	2	2	2
	h	79	100	100	103	103	107
	k	43	32	32	53	53	45
	l	52	55	65	67	67	72
	l1	60	63	72	82	82	85
	α	20°	20°	20°	20°	20°	20°
Borna para cond.	Sección	1,5	1,5	1,5	2,5	2,5	2,5
Transvers. (mm <sup>2</sup> )	min.-máx.	-4	-4	-4	-10	-10	-10

Grupo de artículos : 1044

voltages : 230V

rated current : 16A

pole : 3 pole







IP protection types : IP44

position of ground contact : 6h

packing unit : 0010

Peso : 132 g

**N° DE REF.**

	V	110V	230V	400V	500V	>50-500V	
		Hz	50,60	50,60	50,60	50,60	100-300
Color código							
Amperios							
16 A	3	1462	<b>1463</b>	1464		3186	3187
	4	1465	1466	1467	1468	1469	1470
	5	1471	1472	1473	3188	3189	3190
32 A	3	1491	1492	1493		3201	3202
	4	1494	1495	1496	1497	1486	1487
	5	1498	1499	1500	3191	3192	3193