

N° de Ref. : 1473

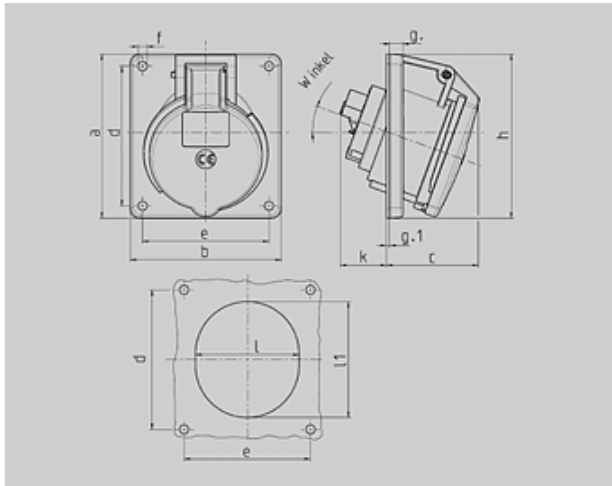





Base semiempotrable

inclinación 20°



Plano	Amp.	16			32		
		Polos			3	4	5
Dim. en mm	a	73,5	100	100	100	100	100
	b	64	92	92	92	92	92
	c	52	58	58	62	62	62
	d	60	85	85	85	85	85
	e	52	77	77	77	77	77
	f	5,5	5,5	5,5	5,5	5,5	5,5
	g	7	8	8	8	8	8
	g.1	2	2	2	2	2	2
	h	79	100	100	103	103	107
	k	43	32	32	53	53	45
	l	52	55	65	67	67	72
	l1	60	63	72	82	82	85
	α	20°	20°	20°	20°	20°	20°
	Borna para cond. Transvers. (mm ²) min.-máx.		1,5 -4	1,5 -4	1,5 -4	2,5 -10	2,5 -10

Grupo de artículos :	1044
voltages :	400V
rated current :	16A
pole :	5 pole
IP protection types :	IP44
position of ground contact :	6h
packing unit :	0010
Peso :	197 g

N° DE REF.		110V	230V	400V	500V	>50-500V	
		50,60	50,60	50,60	50,60	100-300	300-500
Color código	Amperios						
	16 A	3 1462	1463	1464		3186	3187
		4 1465	1466	1467	1468	1469	1470
	5 1471	1472	1473	3188	3189	3190	
32 A	3 1491	1492	1493		3201	3202	
	4 1494	1495	1496	1497	1486	1487	
	5 1498	1499	1500	3191	3192	3193	