

N° de Ref. : 1151A

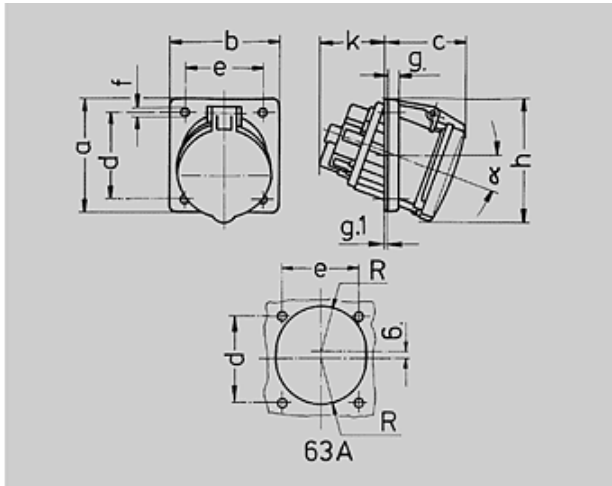





Base semiempotrable

inclinación 20°



Plano	Amp.	63		
		3	4	5
1 MB 297	Polos			
Dim. en mm	a	110	110	110
	b	106	106	106
	c	85	85	85
	d	85	85	85
	e	77	77	77
	f	6,2	6,2	6,2
	g	12	12	12
	g.1	2	2	2
	h	122	122	122
	k	69	69	69
	R	46	46	46
	α	20°	20°	20°
	Borna para cond.	Sección	6	6
Transvers. (mm²)	min.-máx.	-25	-25	-25

Grupo de artículos :	1044
voltages :	400V
rated current :	63A
pole :	4 pole
IP protection types :	IP44
position of ground contact :	6h
packing unit :	0005
Peso :	570 g

N° DE REF.		110V	230V	400V	500V	>50-500V	
V		110V	230V	400V	500V	100-300	300-500
Hz		50,60	50,60	50,60	50,60	100-300	300-500
Color código							
Amperios							
63 A	3	1146A	1147A				
	4		1150A	1151A	1152A		
	5			1155A			