

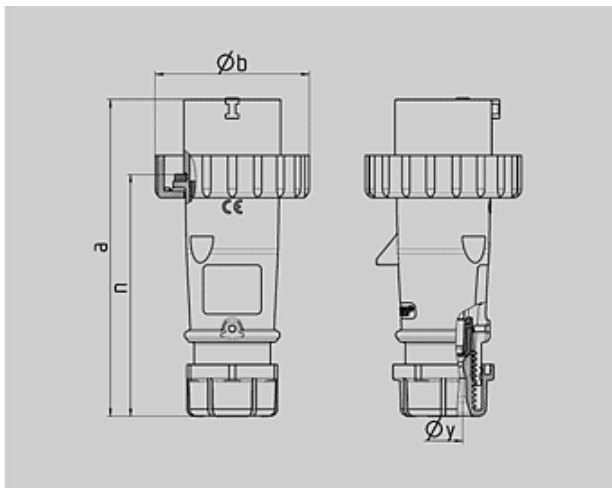

N° de Ref. : 288







**Clavija AM-TOP**

carcasa de una pieza, prensaestopas roscado con estanqueidad, antitracción y protección contra doblado del cable



Plano	Amp.	16			32		
		2 MB 218 Polos			3	4	5
Dim. en mm	a	142	144	147	186	186	180
	b	70	78	87	94	94	101
	n	109	111	114	145	145	138
	y	14,5	16	16	22	22	22
Borna para cond. Transvers. (mm <sup>2</sup> ) min.-máx.	Sección	1	1	1	2,5	2,5	2,5
		-2,5	-2,5	-2,5	-6	-6	-6

Grupo de artículos : 2049
voltages : 400V
rated current : 16A
pole : 5 pole
IP protection types : IP67
position of ground contact : 6h
packing unit : 0010
Peso : 195 g

N° DE REF.		110V	230V	400V	500V	>50-500V	
Hz		50,60	50,60	50,60	50,60	100-300	300-500
Color código							
Amperios							
16 A	3	277	278	279			
	4	280	281	282	283	284	285
	5	286	287	<b>288</b>			
32 A	3	289	290	291			
	4	292	293	294	295	296	297
	5	298	299	300			