

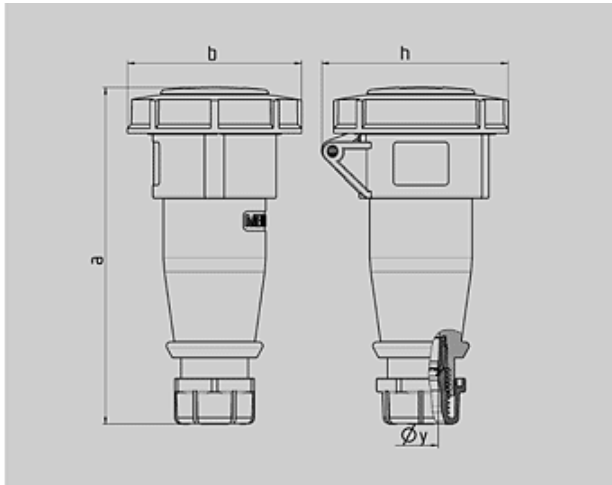

N° de Ref. : 540

Prolongador AM-TOP

carcasa de una pieza, prensaestopas roscado con estanqueidad, antitracción y protección contra deformaciones del cable



| Plano | Amp. | 16 | | | 32 | | |
|--|-------|-----------|-----------|-----------|-----------|-----------|-----------|
| | | 3 MB 62 | | | 3 MB 62 | | |
| | Polos | 3 | 4 | 5 | 3 | 4 | 5 |
| Dim. en mm | a | 146 | 166 | 172 | 212 | 212 | 213 |
| | b | 72 | 79 | 89 | 96 | 96 | 102 |
| | h | 80 | 88 | 95 | 98 | 98 | 105 |
| | y | 14,5 | 16 | 16 | 22 | 22 | 22 |
| Borna para cond. Sección Transvers. (mm ²) min.-max. | | 1 -2,5 | 1 -2,5 | 1 -2,5 | 2,5 -6 | 2,5 -6 | 2,5 -6 |

Grupo de artículos : 3149

voltages : 230V

rated current : 16A

pole : 3 pole







IP protection types : IP67

position of ground contact : 6h

packing unit : 0010

Peso : 165 g

N° DE REF.

| | V | 110V | 230V | 400V | 500V | >50-500V | |
|--------------|----|---|---|---|---|---|---|
| | Hz | 50,60 | 50,60 | 50,60 | 50,60 | 100-300 | 300-500 |
| Color código | |  |  |  |  |  |  |
| Amperios | | | | | | | |
| 16 A | 3 | 539 | 540 | 541 | | | |
| | 4 | 542 | 543 | 544 | 545 | 546 | 547 |
| | 5 | 548 | 549 | 550 | | | |
| 32 A | 3 | 551 | 552 | 553 | | | |
| | 4 | 554 | 555 | 556 | 557 | 558 | 559 |
| | 5 | 560 | 561 | 562 | | | |