

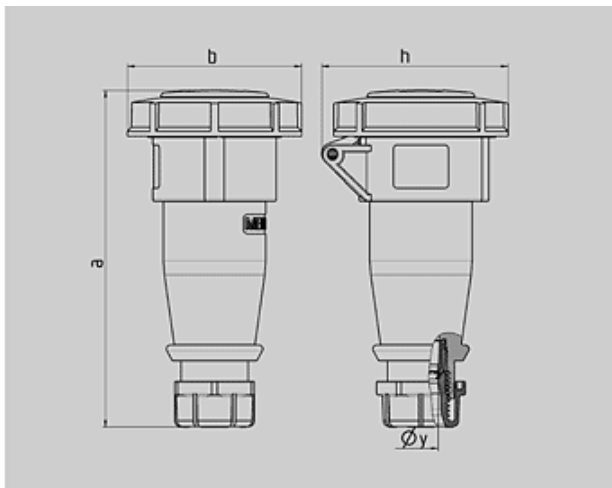

N° de Ref. : 544







Prolongador AM-TOP

carcasa de una pieza, prensaestopas roscado con estanqueidad, antitracción y protección contra deformaciones del cable



Plano	Amp.	16			32		
		3 MB 62			3 MB 62		
	Polos	3	4	5	3	4	5
Dim. en mm	a	146	166	172	212	212	213
	b	72	79	89	96	96	102
	h	80	88	95	98	98	105
	y	14,5	16	16	22	22	22
Borna para cond. Sección Transvers. (mm ²) min.-max.		1 -2,5	1 -2,5	1 -2,5	2,5 -6	2,5 -6	2,5 -6

Grupo de artículos : 3149
voltages : 400V
rated current : 16A
pole : 4 pole
IP protection types : IP67
position of ground contact : 6h
packing unit : 0010
Peso : 200 g

N° DE REF.		110V	230V	400V	500V	>50-500V	
Hz		50,60	50,60	50,60	50,60	100-300	300-500
Color código							
Amperios							
16 A	3	539	540	541			
	4	542	543	544	545	546	547
	5	548	549	550			
32 A	3	551	552	553			
	4	554	555	556	557	558	559
	5	560	561	562			