

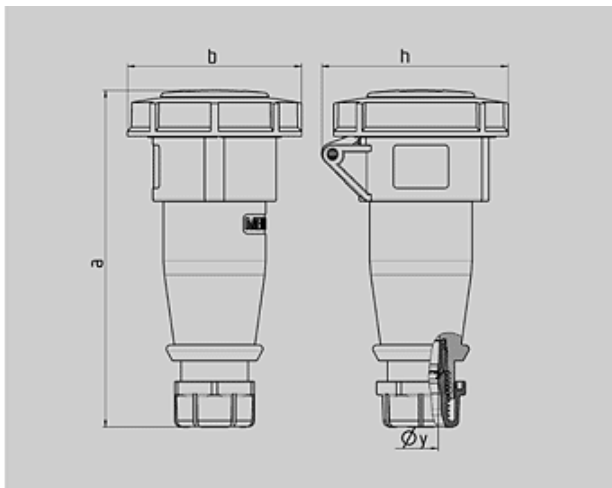

N° de Ref. : 550







Prolongador AM-TOP

carcasa de una pieza, prensaestopas roscado con estanqueidad, antitracción y protección contra deformaciones del cable



Plano	Amp.	16			32		
		3 MB 62			Polos		
		3	4	5	3	4	5
Dim. en mm	a	146	166	172	212	212	213
	b	72	79	89	96	96	102
	h	80	88	95	98	98	105
	y	14,5	16	16	22	22	22
Borna para cond. Transvers. (mm ²) min.-max.		1	1	1	2,5	2,5	2,5
		-2,5	-2,5	-2,5	-6	-6	-6

Grupo de artículos :	3149
voltages :	400V
rated current :	16A
pole :	5 pole
IP protection types :	IP67
position of ground contact :	6h
packing unit :	0010
Peso :	235 g

N° DE REF.		V	110V	230V	400V	500V	>50-500V	
		Hz	50,60	50,60	50,60	50,60	100-300	300-500
Color código								
Amperios								
16 A	3	539	540	541				
	4	542	543	544	545	546	547	
	5	548	549	550				
32 A	3	551	552	553				
	4	554	555	556	557	558	559	
	5	560	561	562				