

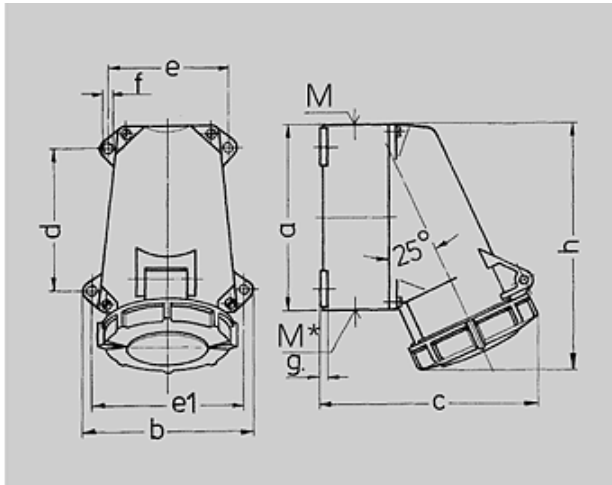

N° de Ref. : 1196







Base

con cuatro fijaciones exteriores, una entrada de cable superior y una ciega (para cortar) inferior



Plano	Amp.	16			32			
		1 MB 219 Polos			3	4	5	
Dim. en mm	a	95	95	95	120	120	120	
	b	102	102	102	112	112	112	
	c	115	124	129	143	143	150	
	d	64,2	64,2	64,2	90,2	90,2	90,2	
	e	77,5	77,5	77,5	79	79	79	
	e1	88	88	88	98,5	98,5	98,5	
	f	5,5	5,5	5,5	5,5	5,5	5,5	
	g	5	5	5	5	5	5	
	h	128	128	132	160	160	160	
	M	20	25	25	32	32	32	
	M*	20	25	25	M 32 (ciega)			
	Diám. máx. de cable (mm)	(ciega) para cortar	15	18	18	25 para cortar		
	Borna para cond. Sección Transvers. (mm ²) min.-máx.		1,5	1,5	1,5	2,5	2,5	2,5
			-4	-4	-4	-10	-10	-10

Grupo de artículos :	1049
voltages :	400V
rated current :	16A
pole :	4 pole
IP protection types :	IP67
position of ground contact :	6h
packing unit :	0010
Peso :	270 g

N° DE REF.		110V	230V	400V	500V	>50-500V	
Hz		50,60	50,60	50,60	50,60	100-300	300-500
Color código							
Amperios							
16 A	3	1193	1192	1211			
	4	1194	1195	1196	1197	1212	1213
	5	1198	1199	1200			
32 A	3	1201	1202	1203			
	4	1204	1205	1206	1207	1214	1215
	5	1208	1209	1210			