

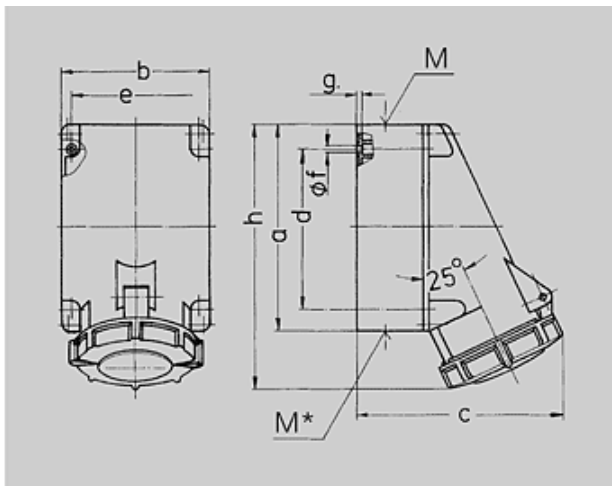

N° de Ref. : 136A







Base SoftCONTACT

Fijación interior, una entrada de cable superior y dos ciegas (para cortar) inferiores, parte inferior de la carcasa giratoria 180°, preparada para 6 bornes de conexión AM



Plano 1 MB 112	Amp. Polos	63		
		3	4	5
Dim. en mm	a	170	170	170
	b	118	118	118
	c	171	171	171
	d	134,5	134,5	134,5
	e	103	103	103
	f	6,1	6,1	6,1
	g	6	6	6
	h	216	216	216
	M	40	40	40
	M*		2x M 40	
	Diám. máx. de cable (mm)		32	32
Borna para cond. Sección Transvers. (mm ²) min.-max.		6 -25	6 -25	6 -25

Grupo de artículos :	1049
voltages :	400V
rated current :	63A
pole :	5 pole
IP protection types :	IP67
position of ground contact :	6h
packing unit :	0005
Peso :	970 g

N° DE REF.		110V	230V	400V	500V	>50-500V	
		50,60	50,60	50,60	50,60	100-300	300-500
Color código	Amperios						
63 A	3	856	128A	129A			
	4	130A	131A	132A	133A		
	5	134A	135A	136A	2007A		