

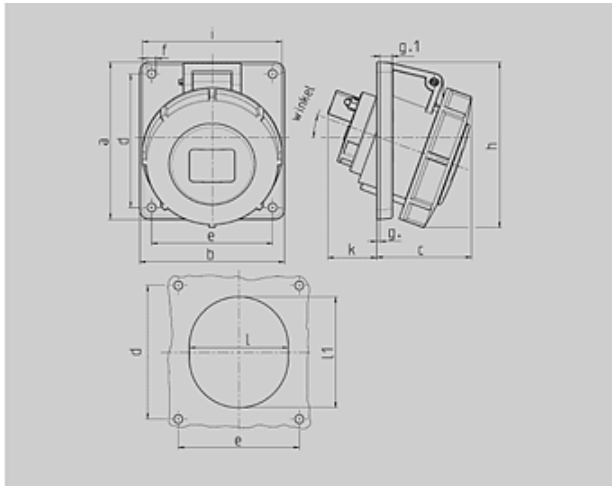

N° de Ref. : 1485







**Base semiempotrable**

inclinación 20°



Plano	Amp.	16			32		
		1 MB 251			Polos		
Dim. en mm		3	4	5	3	4	5
a		73,5	100	100	100	100	100
b		64	92	92	92	92	92
c		52	60	62	64	64	66
d		60	85	85	85	85	85
e		52	77	77	77	77	77
f		5,5	5,5	5,5	5,5	5,5	5,5
g		7	8	8	8	8	8
h		2	2	2	2	2	2
i		84	100	105	109	109	113
k		78	85	96	103	103	110
l		43	32	32	33	53	45
l1		52	55	65	67	67	72
alpha		60	63	72	82	82	85
Borna para cond.		20°	20°	20°	20°	20°	20°
Sección Transvers. (mm²) min.-máx.		1,5 -4	1,5 -4	1,5 -4	2,5 -10	2,5 -10	2,5 -10

Grupo de artículos :	1048
voltages :	400V
rated current :	16A
pole :	5 pole
IP protection types :	IP67
position of ground contact :	6h
packing unit :	0010
Peso :	210 g

N° DE REF.	V					
	110V	230V	400V	500V	>50-500V	
	Hz					
	50,60	50,60	50,60	50,60	100-300	300-500
Color código						
Amperios						
16 A	3	1474	1475	1476		
	4		1478	1479	1480	1481
	5			<b>1485</b>		
32 A	3	1501	1502	1503		
	4		1505	1506	1507	1567
	5			1551		