

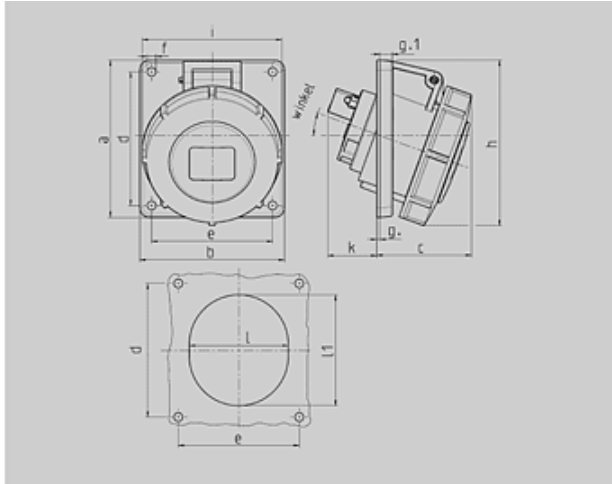

N° de Ref. : 1502







Base semiempotrable

inclinación 20°



Plano	Amp.	16			32		
		Polos			Polos		
1 MB 251		3	4	5	3	4	5
Dim. en mm	a	73,5	100	100	100	100	100
	b	64	92	92	92	92	92
	c	52	60	62	64	64	66
	d	60	85	85	85	85	85
	e	52	77	77	77	77	77
	f	5,5	5,5	5,5	5,5	5,5	5,5
	g	7	8	8	8	8	8
	h	2	2	2	2	2	2
	i	84	100	105	109	109	113
	j	78	85	96	103	103	110
	k	43	32	32	33	53	45
	l	52	55	65	67	67	72
	l1	60	63	72	82	82	85
	α	20°	20°	20°	20°	20°	20°
Borna para cond.	Sección	1,5	1,5	1,5	2,5	2,5	2,5
Transvers. (mm²)	min.-máx.	-4	-4	-4	-10	-10	-10

Grupo de artículos :	1048
voltages :	230V
rated current :	32A
pole :	3 pole
IP protection types :	IP67
position of ground contact :	6h
packing unit :	0010
Peso :	260 g

N° DE REF.	V	110V	230V	400V	500V	>50-500V	
		Hz	50,60	50,60	50,60	50,60	100-300
Color código	Amperios						
	16 A	3	1474	1475	1476		
		4		1478	1479	1480	1481
	5			1485			
32 A	3	1501	1502	1503			
	4		1505	1506	1507	1567	
	5			1551			